

3nh

**PRECISE
GLOSS METER**

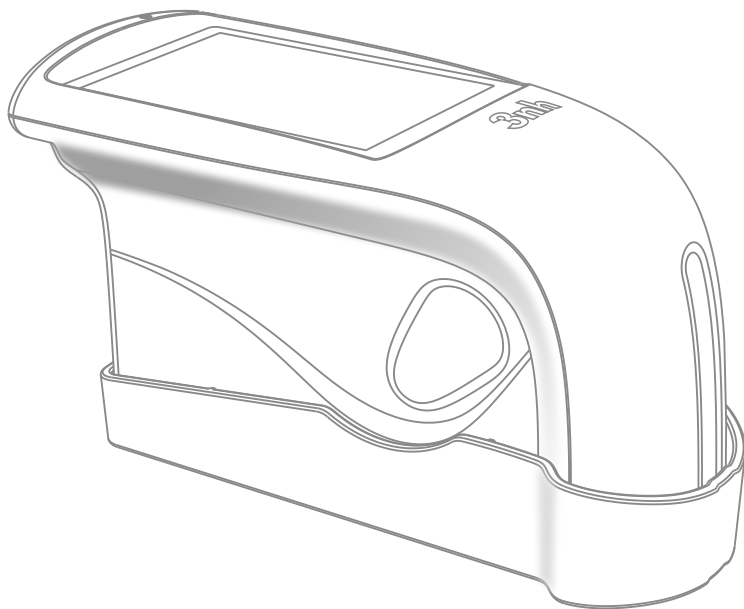









OPERATION MANUAL



60° / 20° 60° 85° V3.0

Safety Instructions

Attention: The instrument is a safe device. Before operating, please read the safety instructions and strictly comply with the following terms to avoid unexpected damages. We shall not be liable for any losses by incorrect operation.

Battery	<ul style="list-style-type: none"> The device configures a built-in battery. Please use the original one. Do not use other batteries to prevent unnecessary damages. Do not disassemble, extrude or heat the battery. When fully charged, please cut off the external power supply in time. Please charge the battery biweekly if long time not use. Otherwise, it may cause the damage of the battery. For the first three times, please run out the power and charge full to ensure the battery reach the optimal state.
External Power Source	<ul style="list-style-type: none"> Please use the original power adapter when charging. Otherwise, it will shorten the battery life or cause explosion. Please cut off the external power source if you don't use it for a long time.
Gloss Meter	<ul style="list-style-type: none"> Do not use the device in inflammable and explosive environment. Do not disassemble the device which will cause damage explosion. Please stop using the machine when you smell something burning and send it back to repair center.

Introduction

The gloss meter is in accordance with ISO 2813(International Standard) and GB/T 9754(China National Standard). It has the characters of easy to use, stable performance and precise measurement.

Advantages

1. Large Screen (3.5inch), high resolution (480*320), full-view display.
2. Comply with ISO 2813、GB/T 9754、ASTM D 523、ASTM D 2457 standards.
3. Aesthetic design perfectly combined with ergonomics structure.
4. Three measurement angles (20°, 60°, 85°), can measure simultaneously (except the single-angle gloss meter).
5. QC software with powerful extending function (except certain models).
6. Flexible choice of auto-calibrating when power on, easy to operate.
7. Display multiple sets of data, easy to compare.
8. High hardware configuration with multiple innovative technologies.
9. Built-in rechargeable battery, economical and environmental protection.
10. Auto power-off function to save electricity consumption.

Cautions

1. The gloss meter is a precise measuring instrument. Please avoid dramatic change of external environment when measuring. Those changes including the flicker of surrounding light, the rapid change of temperature and humidity will affect the measuring accuracy.
2. Keep the instrument balanceable. Make sure the measuring aperture cling to the test sample, and no shaking or shifting when measuring. Please prevent the gloss meter from fierce collision or crash. This device is not water-proof. Do not use it in the environment of high humidity or in the mist.
3. Keep the device clean. Avoid dust, powder or solid particles entering the measuring aperture and the devices.
4. After using, please turn it off. Keep the instrument and calibration board in the instrument case.
5. Keep the instrument in a cool, dry environment.
6. Users can not do any changes on the device without permission. Since it may affect measuring accuracy or even damage the device.

1. External Constructions

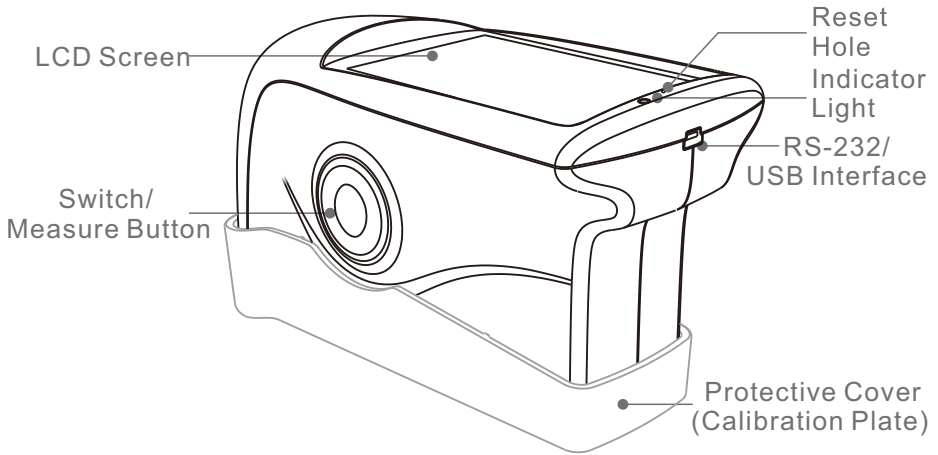

Figure 1 External Constructions

LCD Screen: Display measuring data and instrument operation navigation.

Switch/Measure button: Long-press the button 3 seconds to turn on or turn off the gloss meter. Short press the button is to measure.

Indicator Light: When turning on, it will show green light. After startup, the light is off. Low power and charging status will show red light. Fully charged will show green light.

USB interface: This interface is a common interface. The instrument automatically judges the connection status. USB interface is used to connect transfer data to PC. RS-232 interface is used to connect to the printer. USB cable can connect power adapter and computer for charging the gloss meter (specification for external adapter is: 5V = 2A).

Protective Cover (Calibration plate): It is to protective the measuring aperture. Built-in calibration plate is used for instrument calibrating.

Hardware Reset Hole: When the instrument has a disfunction (the instrument has no reaction when press the measuring button), use a pin to plug into the reset hole and keep it for 3s, the instrument will restart.

* **Attention:** The method to separate the protective cover from the instrument is shown in figure 2. Hold the instrument with one hand, the other hand hold the protective cover, and then separate it according to the “Open” mark. You only need to separate it from one side. Do not separate it from two sides.

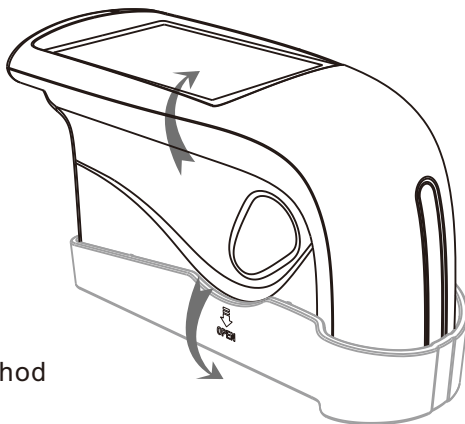

Figure 2 Separation Method

2. Operating Instruction

2.1 Turn on/off

Long-press the switch button 3 seconds to turn on the instrument. The LCD screen will display boot logo. After a few seconds, it will enter into the measurement interface automatically, as shown in figure 3. Long-press the switch button 3 seconds again, it will be turn off.

The instrument will enter the standby mode if without operation within five minutes. And it will turn off atomically if without operation within one minute in standby mode.

Sample Measure		
T005		16:12 2015.10.23
60°		
T001	T102316	22.5
T002	T102316	23.8
T003	T102316	33.3
T004	T102316	45.5
T005	T102316	60.5

Figure 3 Single Angle Measurement

2.2 Calibration

Auto-Calibrating Description

The instrument has auto-calibrating function. But for flexible use, it has optional designation to judge whether it will auto-calibrate at startup. If the last power-off is manually, it will calibrate automatically when turn on next time. If the last power-off is automatic after 5 minutes backlight off, then it will not calibrate automatically when turn on next time.

When operating environment change (such as the rapid change of temperature, altitude and humidity), it must do calibration. In order to ensure the accuracy, please use the original standard plate for calibration. The dust on the standard plate will affect calibration accuracy. Please clean the standard plate and ensure it's clean when calibrating.

The Standard plate is a precise optical component. Please avoid it from strong sunlight. Due to environment factors, the gloss value of standard plate will change over time. Therefore, it's better to send it back to the factory or qualified local National Institute of Metrology for the calibration. (Once a year)

Attention:a)Each instrument has the only calibration plate. If use other calibration plate to pass the calibration, the measurement is also not accurate. Therefore, before calibrating, please check whether the serial number of the instrument is the same with that on the calibration plate.

b)Before calibrating, please make sure the instrument and calibration plate is tightened. Otherwise, the calibration maybe failed and the measurement results may not accurate.

Change Calibration Values

Users can change instrument calibration value through QC software.

Attention: Modify calibration value is better operated by manufacturer or qualified metrological institutes. The calibration value needs to be modified only when it is different from the actual calibration plate value. Before modifying the standard value, please backup the original standard value.

2.3 Measurement

The measuring mode is basic mode (Figure 4).

Basic mode is a basic sample test mode which will display the glossiness

value directly. It belongs to single measurement. The results will be saved automatically each time (except for certain models). It can display multiple sets of test data simultaneously.

Sample Measure				
T005		16:12 2015.10.23		
		20°	60°	85°
T001	T102316	22.5	21.5	21.3
T002	T102316	23.8	24.8	26.6
T003	T102316	33.3	31.5	32.7
T004	T102316	45.5	42.9	42.1
T005	T102316	60.5	66.3	63.9

Figure 4 Multi-angle Measurement

“T005” at the upper left means the record number of the last measurement.

“16:12” and “2015.10.23” are time and date.

“T001-T005” is the record number of five measurements. (Some models only display three records.)

“T102316” is a default name of measuring record. It is making up of “T+”month”+”day”, “T” means basic record, “102316” means the measuring record at 16:00 pm on 23th October.

The last record will show in yellow.

2.4 Data Save

It defaults to save data automatically. Users can set not-save function through QC software.

The instrument can save 1000 data. When it's full, it will prompt. If continue to measure, the new record will cover the last one. Users can delete data or manage other operations through QC software. (Remarks: some models don't have this function.)

2.5 Connecting to PC

Turn on the instrument, connect USB to PC. Then the instrument is charging and it will connect the software automatically. Users can control the measurements through QC software.

Remarks: Some models don't have this function.

2.6 Print

If the gloss meter connects miniature printer, it will print the testing data when measuring.

3. Function Description of QC Software

When connecting to QC software, users can manage following operations:

- a)Check Status (Instrument basic information, such as model, serial number)
- b)Calibrate
- c)Change Calibration Value (It's better to handle by manufacturer of qualified metrological institutes.)
- d)Data Management (Check record, delete record, export record, print report)
- e)Set Time and Data
- f)Set Language
- g)Select Angles (only for tri-angle gloss meter)
- h)Set Auto Save or Not-save Function.

4. Routine Maintenance

(1)The gloss meter is a precise instrument. Please operate and store it in standard laboratory environment (Temperature: 20℃ , Standard atmospheric pressure, Humidity: 50~70%RH). Please avoid using it in humid environment, strong electromagnetic interface environment, high light intensity environment and dusty environment.

(2)Standard plate is a precise optical component. Avoid being damaged by sharp object, avoid dirtying the board and avoid exposing it to sun. Regularly clean the standard plate by using soft cloth with alcohol in one direction. Ensure there are no tiny particles or sundries on the soft cloth. Before calibrating, clean the standard plate to make accurate calibration.

Attention: Forbid to use acetone solvent!

(3)In order to ensure the accuracy of the instrument, it is better send it back to the factory or qualified Local National Institute of Metrology for calibration. (Once a year)

(4)It needs to modify calibration value when the calibration value is different from practical measurement value. View chapter 2.2 for details.

(5)The gloss meter is powered by built-in battery. When long time not using this instrument, please charge it biweekly in order to protect the battery and extend the battery life.

(6)The internal clean work of the instrument should be finished by manufacturer (suggest once a year). Do not use cleaning tools to clean the internal instrument. Otherwise it will cause irreversible damage.

5. Technical Specifications

Measurement Angle	20° /60° /85° /20° 60° 85°						
Standard	ISO 2813,GB/T 9754,ASTM D 523,ASTM D 2457						
Measuring Area(mm)	20°: 10x10, 60°: 9x15, 85°: 5x36						
Measuring Range	Multi-angle Models		Single Models			Some Single Models	
	20°: 0~1000GU 60°: 0~1000GU 85°: 0~160GU		60°: 0~300GU			60°: 0~200GU	
Division Value	Some Models: 0.1 GU			Some Models: 1 GU			
Range	Multi-angle Models			Single Models			Some Single Models
	0~10GU	10~100GU	100~1000GU	0~10GU	10~100GU	100~300GU	0~200GU
Repeatability	±0.1GU	±0.2GU	±0.2%GU	±0.1GU	±0.2GU	±0.2%GU	±1GU
Reproducibility	±0.2GU	±0.5GU	±0.5%GU	±0.2GU	±0.5GU	±0.5%GU	±1GU
Chromaticity Corresponding	Corresponding with CIE 1931(2°) under CIE C light source						
Measuring Time	0.5second						
Dimension	L*W*H : 160mm*75mm*90mm						
Weight	350g						
Battery	3200mAh Li-ion Battery, >10000 times (within 8 hours)						
Display	TFT 3.5inch, resolution: 320*480						
Interface	USB/RS-232						
Storage	1000 (This function is not available for some models.)						
Software	GQC6 Quality Control Software with QC report printing function and more extended functions (except certain models).						
Operation Temperature	0~40°C (32~104° F)						
Storage Temperature	-20~50°C (-4~122° F)						
Humidity	<85% relative humidity, no condensation						
Standard Accessories:	Power Adapter, USB cable, User Manual, CD (Including QC software), Wiping Cloth, Calibration Plate						
Optional Accessories	Miniature Printer						

*Note:The specifications are subject to change without notice.

